

STAINLESS STEEL FLUE FITTINGS

Ø80, Ø100 & Ø130MM

DIMENSIONAL DATA SHEET



Ø80mm

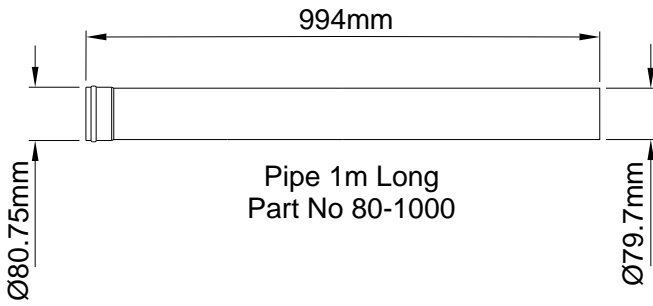

Pipe 1m Long
 Part No 80-1000

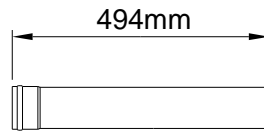

Pipe 0.5m Long
 Part No 80-500

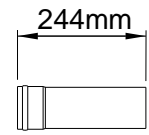

Pipe 0.25m Long
 Part No 80-250

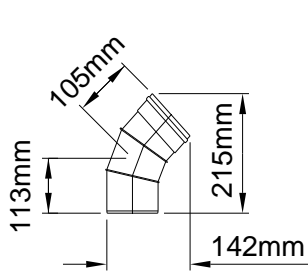

Elbow 45°
 Part No 80-45

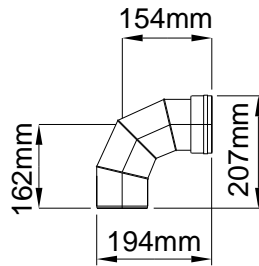

Elbow 90°
 Part No 80-90

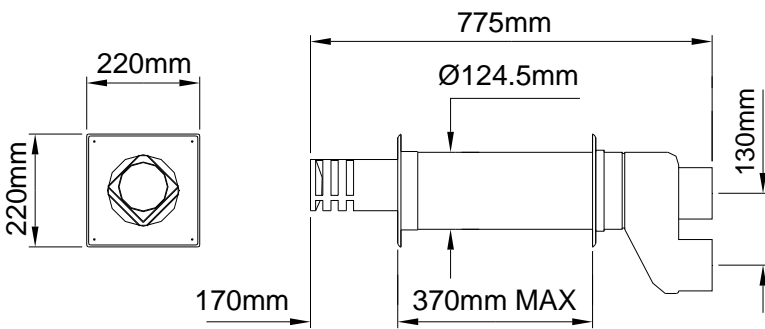

Horizontal Concentric Terminal Assembly
 Part No H-80

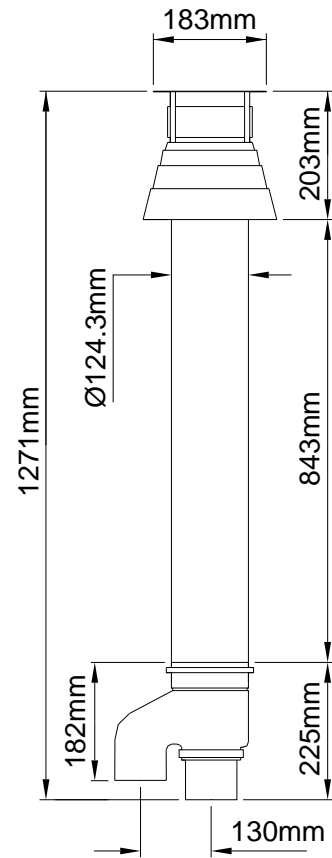

Vertical Concentric Terminal Assembly
 Part No V-80

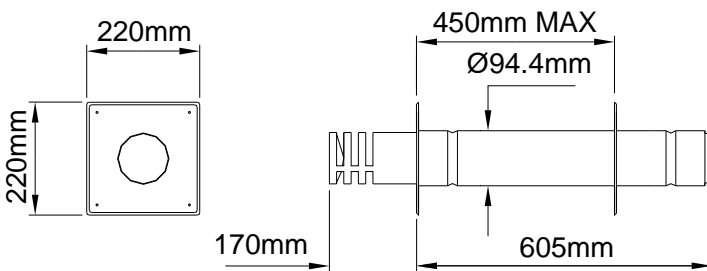

Horizontal Flue Terminal Type B
 Part No HC-80

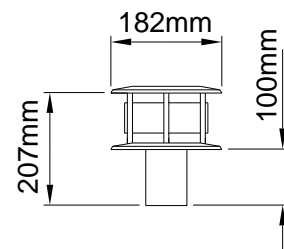

Vertical Flue Terminal
 Part No VC-80

Ø100mm

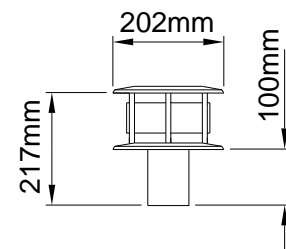
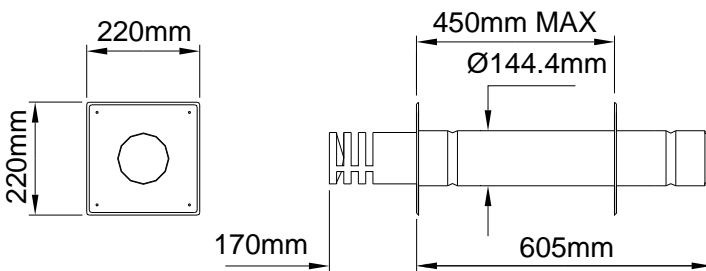
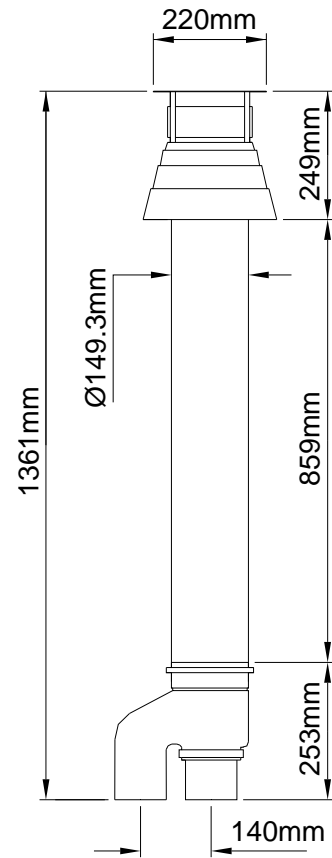
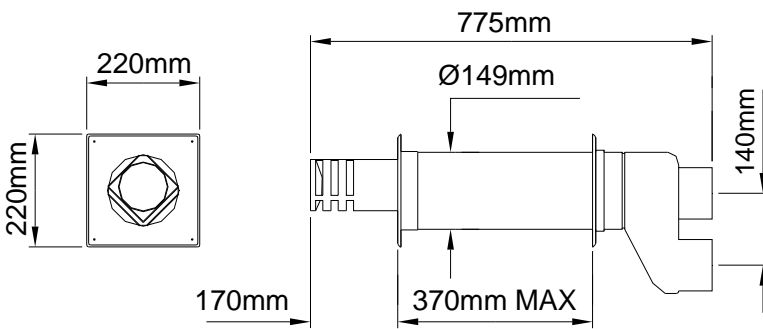
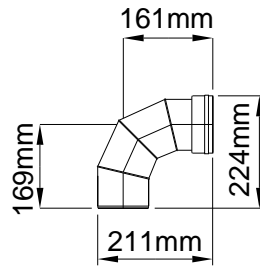
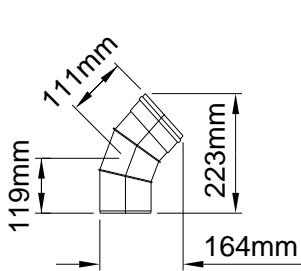
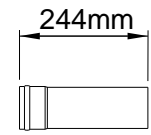
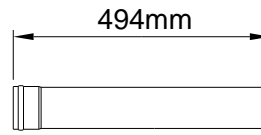
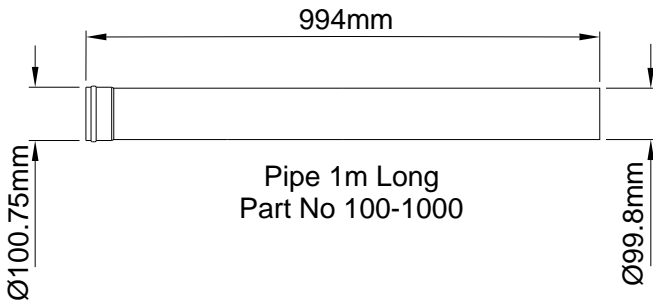

Ø130mm

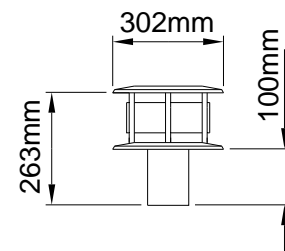
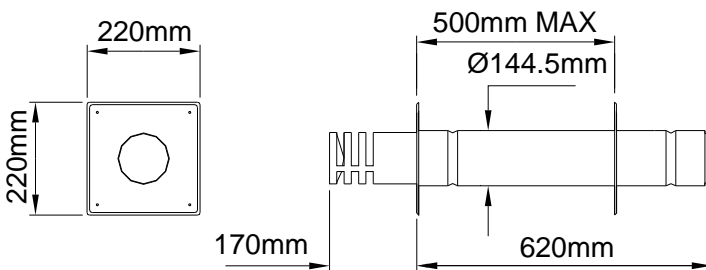
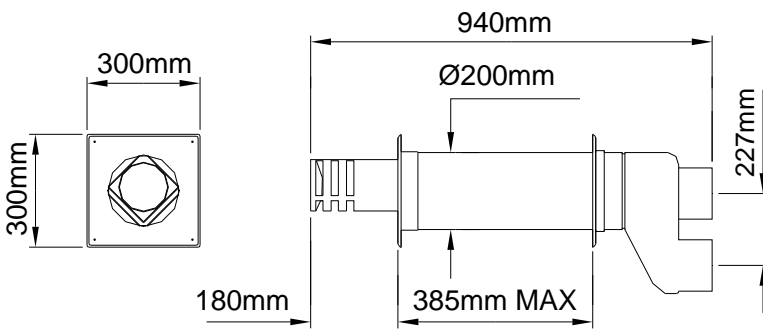
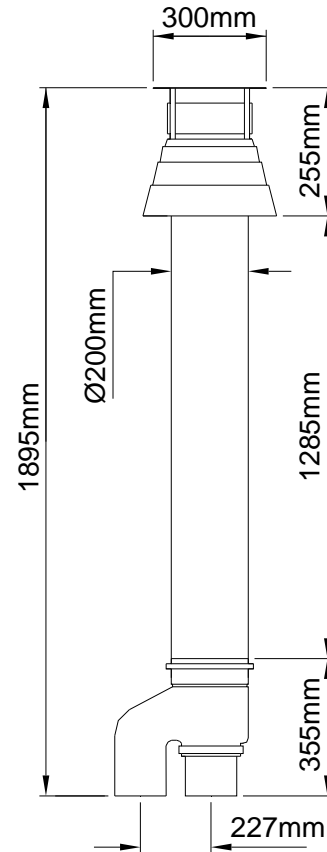
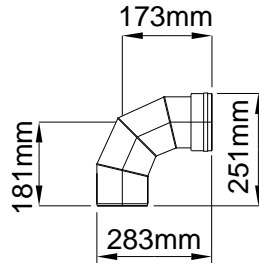
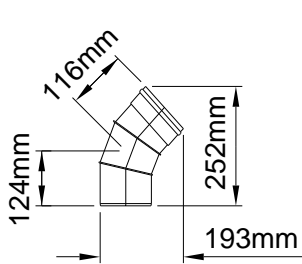
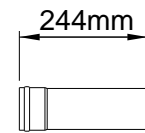
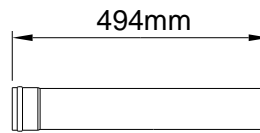
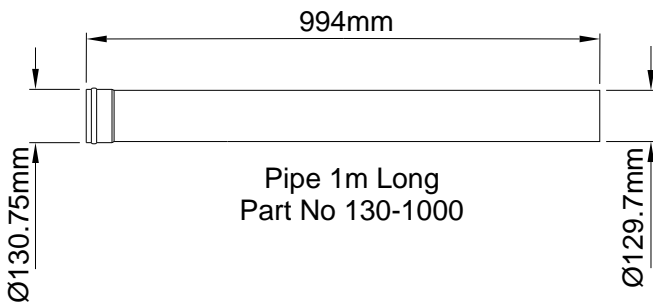

Benson Heating Ludlow Road Knighton
Powys LD7 1LP United Kingdom.

Telephone 01547 528534
Facsimile 01547 520399
Email sales@bensonheating.co.uk
Website www.bensonheating.co.uk



Benson Heating Ltd is a registered trademark of AmbiRad Limited. Because of continuous product innovation, Benson Heating reserve the right to change product specification without due notice.